

Mobile X6 4G LTE

Wireless Booster
Extreme Power

 6 BAND
MULTI BAND

50dB

User Manual

BMUX650
USA

Cellular *RX/TX* **50dB 6 BAND**
Signal Booster **MULTI BAND 50dB**

Wireless Booster Extreme Power

2G, 3G, 3G+, 4G, 4G+

GSM, HSPA, CDMA, LTE, LTE A

Band 12,17 700MHz Lower

Band 13 700MHz Upper

Band 5 850MHz

Band 4 1700/2100MHz

Band 2,25 1900MHz ext



SPECIFICATIONS

2G, 3G, 3G+, 4G, 4G+, GSM, HSPA, CDMA, LTE, LTE A

Frequencies MHz	700 MHz upper	700 MHz lower	850 MHz	1700/2100 MHz	1900 MHz
Model Series	BMUX650				
Gain	50 dB				
Max Power-TX: Watts EIRP	1				
Operating temp	-22 F TO + 185 F	POWER SUPPLY		12V DC CLA OR 12V DC fused or 120V AC/DC	
Dimensions	L 4.72 x W 4.25 x H 1.25 (inch)			Weight	1.2 lb

1-877-726-3444

Smoothtalker.com

Contents

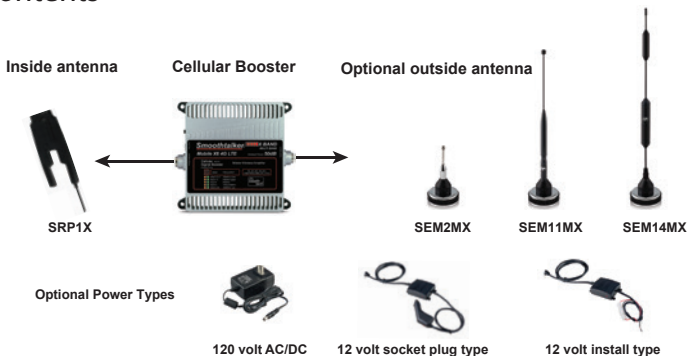

NOTE: Only one of the outside antennas is included in this kit (check model) All kits include necessary brackets and co-axial cables for assembly. It is normal for the booster to be quite warm while the phone is in use state.

To comply with FCC rules, this booster must only be operated with cables, antennas and coupling devices that have been approved for use with this equipment.

Applications

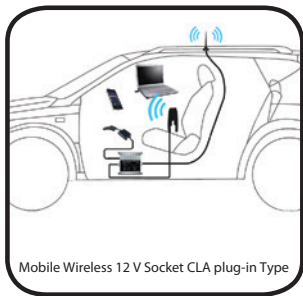

Fig. 1

Typical Vehicle Installation Mobile X650 (Fig. 1)
(All parts are included)



Fig. 2

Optional Desktop (Fig. 2)
(Additional parts required which are not included in Booster kit.)

Installation

- 1) Connect the outside antenna to the side of the booster marked as “outside antenna”
Connect the inside antenna to the side of the booster marked as “inside antenna”

2) Placement

Place the outside antenna in the middle of the vehicle roof. If the vehicle has a sunroof please place the antenna on the roof towards the back window. Place the Patch (inside) antenna in desired location. For cars and trucks the console between the front seats is recommended. Connect the booster as shown in Fig. 1 & 2 on Pg.1 or Fig. 3 on Pg. 4.

Important: Use only the power supply included with the booster. Connecting any other power supply at any time will result in damage to the booster and will void the warranty. Do not turn on the power switch until ALL cables have been screwed or plugged into the booster or you can cause damage to the booster.



The Mobile X650
Can easily be moved from the vehicle to a trailer

Understanding the LED Indicators

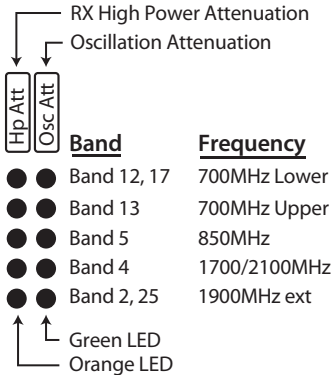
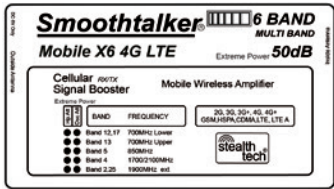

The “LEDS” on the face of the booster indicate operating gain state.

In any given frequency band.

The Green and Orange LED which indicate the gain status i each operating band.

When both of these LEDS are “SOLID ON” it means that the booster is operating normally and with full gain (No Automatic Gain Reduction) .

When one or both of the LEDS are flashing (Per the chart on Pg. 6) it indicates that the gain has been automatically reduced due to either:

- A) High RX outside signal level (close to cell tower)
- B) Loop Oscillation, which is due to the inside antenna (either on holder or Patch antenna) and the outside antennas are located too close together.

When the booster is off it will be indicated as follows:

When inside and outside antennas are extremely close together the Green LED will fast flash and the Orange LED will turn off indicating that the booster is off due to loop oscillation.

LED Lights Explanation and Troubleshooting

Each flash indicates 3dB of gain reduction also known as gain attenuation.
For example: three flashes equals 9dB of attenuation.

Green LED indicates loop oscillation status. When flashing it means reduction of gain. To improve you need to spread the distance between the inside and outside antennas. If you spread them far enough away, the Green LED will become SOLID ON.

Orange LED There are 5 Orange LED lights: 700 Mhz Lower, 700 Mhz Upper, 850 Mhz, 1700/2100 Mhz, 1900 Mhz ext.

LED ON state indicates that the RX (Receive Signal) function of the band is functioning normally.

LED OFF (Green or Orange): indicates that the band is shut down.
When flashing it means reduction of gain also known as attenuation of gain. You cannot prevent this condition. As you drive away from the nearby cell tower and get far enough away the flashing Orange will automatically stop flashing which indicates that the booster is no longer attenuated. As you approach another nearby cell tower the Orange may begin flashing again and will stop flashing as you get farther away. This is the normal operating process.



Typical RV Installation Mobile X650 (Fig. 3)
(All parts are included)

Approved Equipment List









For specifications of any of the Smoothalker FCC approved part numbers listed below visit smoothtalker.com

FCC requirements prohibit the use of unauthorized Antennas, Cables, and/or Coupling devices.

You MUST operate this device with approved antennas and cables as specified by the manufacturer. Antennas MUST be installed at least 8 inches from any person. You MUST cease operating this device immediately if requested by the FCC or a licensed wireless service provider.

ANTENNA CABLES	
ACX100, ACX900	
CBXmaXfe10,20,30,40,50,60	
CBNmaNfe10,20,30,40,50,60	
CBGmaGfe 10,20,30,40,50,60	
ANTENNAS	
SEM2, 11, 14, series	
SEM2M, 11M, 14M, series	
SEM2LGM, 11LGM, 14LGM, 26LGM series	
SEM2LGML 11LGML, 14LGML, 26LGML series	
SEM2TH, 11TH, 14TH, 26TH series	
SEM2THL, 11THL, 14THL, 26THL series	
SEMTHMM series	
SEMTHPB series	
SEMRP1X , SEMRP1XL	
SRBL series	
SEMD1 series	
SEMDA2 series	
SEMO series	
SEMDP1 series	
SEMDY series	
SEMDYD series	

LED Lights Indicate Gain Status

Attenuation (Att) Each flash indicates 3dB of gain reduction also known as gain attenuation. For example: three flashes equals 9dB of attenuation.	ORANGE LED RX High Power	GREEN LED Oscillation
Orange Solid ON = Full Gain & Green Solid ON = Full Gain No Flashing = Full Gain	 SOLID ON	 SOLID ON
Orange Solid ON & Green Slow Flashing = Oscillation Att Each Flash = up to 3dB gain reduction	 SOLID ON	 SLOW FLASHING
Orange Off & Green Fast Flashing = Oscillation Shutdown Fast Flashing = booster shutdown (pls troubleshoot)	 OFF	 FAST FLASHING
Orange Slow Flashing & Green Solid ON = RX High Power Att Each Flash = up to 3dB gain reduction	 SLOW FLASHING	 SOLID ON

Operational description:

To comply with FCC NPS (Network Protection Standard) requirements: NPS and other compliance/safeguard features for AGC and anti-oscillation have been implemented. NPS and other compliance/safeguard features are defaulted to be "On" (in operation).

NPS and other compliance/safeguard features can not be field reconfigured, disabled or removed. This booster is not user programmable, does not need fine tuning or adjustment, does not require professional installation.

This is a CONSUMER device.

BEFORE USE, you MUST REGISTER THIS DEVICE with your wireless provider and have your provider's consent.

Most wireless providers consent to the use of signal boosters. Some providers may not consent to the use of this device on their network. If you are unsure, contact your provider.

Contact information for Booster registration:

Some providers have set up web-sites for booster registration. If you don't see your provider on this list, please contact your provider for information on how to register your booster.

AT&T: <https://securec45.securewebsession.com/attsignalbooster.com/>

Verizon: <http://www.verizonwireless.com/solutions-and-services/accessories/register-signal-booster/>

T-mobile: <https://www.signalboosterregistration.com/>

Sprint: https://www.sprint.com/legal/fcc_boosters.html

Us Cellular: <http://www.uscellular.com/uscellular/support/fcc-booster-registration.jsp>

WARNING. E911 location information may not be provided or may be inaccurate for calls served by using this device.

In 2001 SmoothTalker produced the first digital mobile cellular signal booster in North America with FCC and ICAN approval. We continue to lead with the most powerful and intelligent boosters in the world.

Our dynamic adaptive proprietary algorithms make them very network friendly. We call it STEALTH TECH technology.



Automatic power control protects the Cellular Network

1-877-726-3444

Smoothtalker.com
